

KRELL PLAYBACK SYSTEMS

KPS-20t Transport

KPS-20i Integrated Transport & Processor

KPS-20i/l Integrated Transport, Processor & Digital Preamp

OWNER'S REFERENCE

TABLE OF CONTENTS

2	INTRODUCTION
4	UNPACKING AND PLACEMENT
5	GENERAL DESCRIPTION OF KPS-20 SERIES OWNER'S REFERENCE AC POWER GUIDELINES
6	KPS-20 SERIES FRONT AND REAR VIEW
7	KPS-20 BASIC OPERATION
8	COMPLETE TRANSPORT FEATURES AND FUNCTIONS
13	KPS-20<i>i</i> AND KPS-20<i>i/l</i> DETAILS
15	KPS-20<i>i/l</i> VOLUME CONTROL
16	KPS-20<i>t</i> DETAILS
16	TRANSPORT TO PROCESSOR INTERLINK CONSIDERATIONS
18	TIME SYNC
19	REMOTE CONTROL
22	QUESTIONS AND ANSWERS
24	KPS-20<i>i</i> TYPICAL SYSTEM SETUP
25	KPS-20<i>i/l</i> TYPICAL SYSTEM SETUP
26	KPS-20<i>t</i> TYPICAL SYSTEM SETUP
27	SPECIFICATIONS
28	WARRANTY AND SERVICE

INTRODUCTION

Thank you for your purchase of the KRELL PLAYBACK SYSTEM-20 series component. Influenced by KRELL Reference and Audio Standard Series componets, the KRELL PLAYBACK SYSTEM-20's incorporate the latest developments in Krell technology. Their advanced digital reconstruction system, input and output connection capabilities, ergonomics, and stunning aesthetics make the KRELL PLAYBACK SYSTEM-20 series an impressive statement of audio technology.

KRELL PLAYBACK SYSTEM-20 (KPS-20) series components utilize a top load design based on a high performance Philips transport mechanism. The transport is housed in a solid machined block of brass and independently suspended from the chassis by low-stored-energy isolation mounts. The main chassis provides the first line of shock energy isolation with its own series of low-stored-energy suspension mounts, leaving the inertially massive brass laser chassis to dissipate any residual energy before it can influence the tracking of the laser. Krell-written micro-code controls all transport functions and input selections through a custom user interface. This interface is written with performance and user flexibility as key design goals. Disc stabilization is accomplished with a custom five point magnetic clamp and proprietary hub alignment. The heavy motorized cover assembly isolates the compact disc from ambient light. During playback the underside of the CD is bathed in green light. This particular light spectrum increases the signal-to-noise of the laser's photo-diode which, in turn, increases its reading accuracy.

The KRELL PLAYBACK SYSTEM-20*t* comes standard with all current digital output formats: ST fiber optic, AES/EBU balanced, SPDIF coaxial, EIAJ optical and KRELL Time Sync.

In the KPS-20*i* and KPS-20*i/l* the identical transport mechanism is coupled to an upgradeable software based processor. Data is transferred through custom filter algorithms performing KRELL written reconstructive software at a 16X oversampling rate through a Motorola DSP-56002 processor running at 66 MHz. The 24 bit data is then fed to four differentially configured Burr Brown 20-bit Colinear DAC's.

All critical circuitry utilizes four layer glass epoxy circuit boards. With its 100 VA power supply and 11 independent stages of regulation, the power supply of the KRELL PLAYBACK SYSTEM-20 is a rock solid source of pure current and voltage for the digital and Class A analog output stages. The output stage is classic KRELL. All output circuits are DC coupled, Class A and complementary. The output stage has 18 volt rails and fully differential balanced outputs on gold plated, beryllium copper XLR connectors. Single-ended outputs are also provided via custom gold plated RCA connectors.

In the KRELL PLAYBACK SYSTEM-20*i/l* the high level output stage of the KPS-20*i* is replaced with a line level output stage and volume control similar to that of the KRELL KRC-2 preamplifier. This stage is optimized to drive the input of a power amplifier directly.

The KPS-20*i* and KPS-20*i/l* support all major digital input formats: one ST fiber optic, one AES/EBU balanced, two SPDIF coaxial, and one EIAJ optical. They come standard with an SPDIF coaxial digital output. ST, EIAJ, and KRELL Time Sync outputs are available as an option. All input switching is accessible from the front panel or the remote control. KRELL's proprietary Data Recovery and Jitter Rejection Module recovers all data from external sources, reducing jitter to exceptionally low levels.

This Owner's Reference is intended to guide the clear, trouble free installation and operation of your KRELL PLAYBACK SYSTEM-20. Should you have any questions or comments, please feel free to contact your authorized dealer or the KRELL staff for assistance.

In the unlikely event that your KRELL PLAYBACK SYSTEM-20 should require service, you will be pleased to know that it is backed by a comprehensive Customer Satisfaction policy and one of the most advanced service facilities in the industry. For detailed information on the terms and conditions of service, please consult the Warranty and Service section of this Reference, Warranty Registration Card, or an authorized KRELL Dealer/Distributor.

UNPACKING AND PLACEMENT

1. Once the box is opened and top layer of foam removed, the following items will be visible:

- 1 KPS-20
- 1 KPS-20 Remote Control
- 1 KPS-20 Custom 5 point CD clamp (packed beneath the KPS-20)
- 1 AC power cord
- 1 T-10 torx driver
- 1 Packet containing the Owner's Reference and Warranty
Registration Card

NOTE: If any of these items are not included, please contact your authorized dealer immediately for assistance.

2. Carefully remove the unit and accessories from the box. Remove the protective plastic wrap from the unit.

NOTE: Save all packing materials. If you must ship your KPS-20 in the future, repack the unit in its original packaging to prevent transit damage. KRELL is not responsible for damage incurred during the shipment of goods without factory approved packing material.

PLACEMENT

Before you install the KRELL PLAYBACK SYSTEM-20 into your system, we recommend that you follow these guidelines in choosing the location. This will facilitate a clean, trouble-free installation. The KPS-20 does not require any type of special rack or cabinet for installation. Dimensions are described on page 27.

1. Place the unit on a firm level surface away from excessive heat, humidity or moisture. Make sure there is enough room at the top for a compact disc to be placed within the chassis. Approximately ten inches is necessary.
2. Although well shielded, the KPS-20 should not be placed in close proximity to hum-sensitive components such as preamp phono stages or turntables. The power supply may create interference and induce hum.
3. The KPS-20 incorporates an advanced suspension system and does not require additional mass coupling or isolation. You may experiment with feet or cones as long as they don't permanently affix to the chassis. Any unauthorized modifications to the electronics or chassis will void the warranty.

== GENERAL DESCRIPTION OF KPS-20 SERIES OWNER'S REFERENCE

The features, functions and operation of the transport are identical for all three KPS-20 Series products. Descriptions of them are divided into two sections: Basic Operation provides a quick installation procedure; Complete Transport Features and Functions provides details on all KPS-20 transport capabilities. Features specific to the KPS-20*i*, KPS-20*i/l* and KPS-20*t* are described on pages 13, 15 and 16 respectively.

As with all sophisticated products, a complete reading of this Owner's Reference will provide thorough understanding of the KPS-20 Series products. Please contact your authorized dealer, distributor or the factory if you have any questions not addressed by this Reference.

IMPORTANT NOTE: The use of CD rings, mats, or other devices attached to individual CDs is not recommended. To be completely effective, the KPS-20 clamp must make direct contact with the CD. Otherwise, erratic playback and/or poor sound may occur.

AC POWER GUIDELINES

The KPS-20 has superb regulation and does not require a dedicated AC circuit. We strongly advise against connections through extension cords or multiple AC adapters. High quality 15 amp grounded AC strips are acceptable. High quality AC line conditioners or filters can be utilized if they are grounded and meet or exceed the unit's Power Supply rating of 100VA.

CAUTION: Do not remove or bypass the ground pin on the end of the AC cord. This may cause RFI (radio frequency interference) to be induced into your playback system.

KPS-20 SERIES

FRONT VIEW

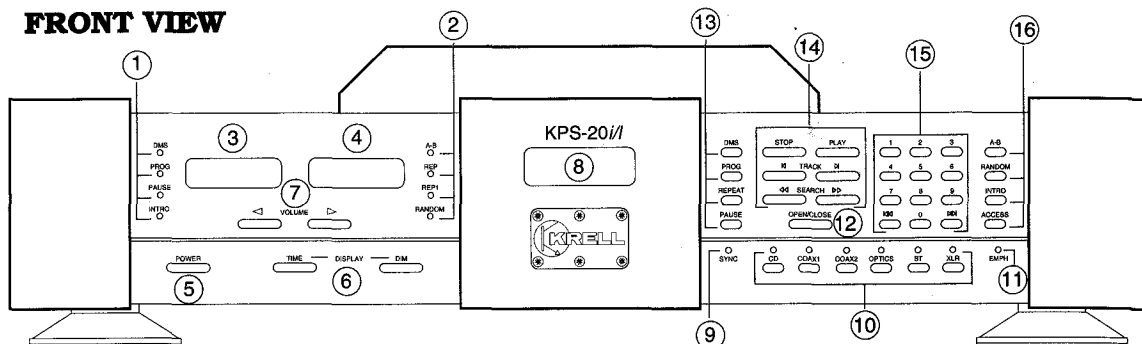

1. Transport function indicators for: Disc Management System, Program, Pause and Introduction
2. Transport function indicators for: A-B loop, Repeat Disc, Repeat Track and Random Play
3. Track and Index number display window
4. Elapsed or remaining time display window; displays volume level on KPS-20i/l
5. Transport Power on/off button
6. Display control buttons
7. Level control buttons for Volume up and Volume down; KPS-20i/l only
8. Infrared remote control receiver window
9. Sync indicator: Displays whether a digital source has linked with the processor
10. Digital Input select buttons and indicators for: Internal CD Transport, External Coax 1, External Coax 2, External EIAJ Optical (Optics), External ST Optical and External AES/EBU XLR balanced
11. Emphasis indicator: Displays whether deemphasis circuitry is engaged
12. Open/Close button for sliding cover
13. Transport function buttons for: Disc Management System, Program, Repeat and Pause
14. Transport function buttons for: Stop, Play, Track Back, Track Forward, Search Back and Search Forward
15. Transport function buttons for: Direct Number Access Keypad, Index Back and Index Forward
16. Transport function buttons for: A-B loop, Random Play, Introduction and Direct Time Access

REAR VIEW

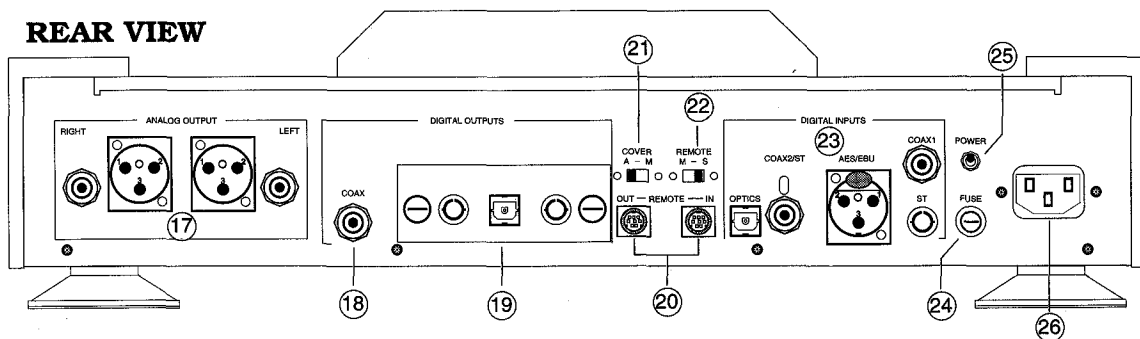

17. Left and Right Balanced and Single-Ended Analog Outputs; not on KPS-20t
18. EIAJ Coax Digital Output
19. Digital Output Module consisting of two ST optical (one can be used for Time Sync) and one EIAJ Optical Output: **Standard** on KPS-20t; **Optional** for KPS-20i and KPS-20i/l
20. Remote In and Out (for use with future switching devices)
21. Manual or Auto Cover Switch
22. Remote Access Switch for use with future switching devices
23. Digital Inputs: EIAJ optical (Optics), Coax 1, Coax 2 or ST optical (optional), AES/EBU, ST optical; not included on KPS-20t
24. Fuse holder
25. Main On/Off Power Switch
26. IEC Standard 15 amp AC power cord receptacle
27. **Not shown**, KPS-20t only: AES/EBU Digital Output

Below are instructions for a quick installation of the KPS-20. Please refer to the Typical System Setup illustrations on pages 24, 25, and 26. Also, allow the unit to settle at room temperature before operation is started.

1. Plug the KPS-20 into the standard wall AC receptacle. Connect the KPS-20 output to the appropriate location: KPS-20*i* to preamp input; KPS-20*i/l* to amplifier or crossover input; KPS-20*t* to D/A processor input. Engage the power switch on the rear panel by pushing it up to the ON position. This powers the processor sections in the KPS-20*i* and KPS-20*i/l*.
2. Press the Power button on the front panel or on the remote control to power the transport stages. The display section will now illuminate. The processor portion of the KPS-20*i* and KPS-20*i/l* is on at all times once the rear panel switch is engaged. This is to insure thermal stability and improve sonic performance.
3. Press the Open/Close button on the front panel and the top cover assembly will open, exposing the CD transport and spindle. Place the compact disc, label side up, onto the drive spindle. Place the five point custom clamp onto the drive spindle, securing the CD in place. Make sure the clamp is centered firmly on the custom CD spindle hub. Press the Open/Close button again or Play and the cover will close.

NOTE: In the event that you wish to rapidly change a number of CDs, the KPS-20 can be played with the cover open. Move the switch on the back panel marked "Manual/Auto" to the "Manual" position. The KPS-20 will now play with the cover open. However, do not forget that you are compromising the quality of the music when the CD is exposed to light. Also, it is always preferable to close the cover when playing music at a high volume in order to maintain optimum tracking.

4. Press Play on the front panel or remote control. *Note: if you pressed Play in step 3 the disc will already be playing.* The disc will start playing from track 1. To select a different track you can press the track forward {>|} or track back {|<} button until you reach the desired track number or punch the number of the desired track into the keypad on the front panel or remote control.
5. Press the Stop button to stop play.

COMPLETE TRANSPORT FEATURES AND FUNCTIONS

The KPS-20 has a wide variety of transport functions. New capabilities have been added to standard functions to enhance the use of the KPS-20. Listed below are the functions which can be accessed from the front panel and remote control.

STOP: Stops the disc while playing. Erases all short term program memory. Does not erase Disc Management System (DMS) data.

PLAY: Starts the disc playing from track 1 or from a keypad-selected track. Begins standard track programming. Pressing the Play button during a track will start that track again from the beginning.

|<: Track Back. Selects and begins playing the track previous to the current track. Also scrolls backward through DMS or standard track programming.

>|: Track Forward. Selects and begins playing the track after the current track. Also scrolls forward through DMS or standard track programming.

|< |<: INDEX Back. Selects the index number previous to the current index number within a specific track if the CD was recorded with separate indexing.

>| >|: INDEX Forward. Selects the next index number within the current track if the CD was recorded with separate indexing.

NOTE: Some discs do not have index numbers programmed within tracks. When the Index buttons are pressed the display will default to the current track number.

<<: Search Back. Fast scroll backward through program.

NOTE: When operating in Search Back the system searches in 5 second increments.

>>: Search Forward. Fast scroll forward through program.

PAUSE: Temporarily stops play of current track. Does not effect DMS or standard track programming. Second press of the Pause button resumes play.

REPEAT: (REP and REP 1) When pressed once, repeats the entire disc, DMS or standard track program indefinitely. When pressed twice, will continuously repeat only the current track. Press Stop or Repeat a third time to cancel this function. When selecting the Repeat function desired, press the Repeat button once and the LED indicator on the faceplate will illuminate. Press the Repeat function twice and the REP 1 indicator LED will illuminate, indicating only a single track will repeat.

0-9 NUMBERED KEYPAD: The direct access keypad makes track selection quick and easy. When using the direct track access function, the selected track will begin play immediately after a one or two digit number is selected. Select the number of your choice directly or follow the program selection sequence if writing a program..

RANDOM: Will play tracks in a non-selected order. Press the Random button and the disc will begin play in a sequence other than the original. Press again and another randomly selected track will play. Press Stop to exit the Random play mode.

INTRO: Plays a 20 second sample of each track on the disc. Press the Stop button to resume normal play.

DISPLAY: Toggles between the time into the current track and the amount of total disc time remaining.

DIM: Shuts off the display and function LEDs. Second press activates the display and function LEDs.

A/B: The KPS-20 can make a loop between two pre-determined points within a track. This is helpful when you need to repeat a specific segment of a track.

How to Create an A/B Loop:

Start play of track. When you hear the part that you want as the beginning of the loop press A/B to insert the start position. Press A/B again to insert finish position. A/B play will automatically begin and continue indefinitely. Press Stop or A/B again to delete the A/B program.

ACCESS: The Access function gives you the ability to numerically select a position within a specific track program. This is valuable when exact start positions are critical.

COMPLETE TRANSPORT FEATURES AND FUNCTIONS

How to Gain Access to a Specific Time in a Track:

1. Press Access. Two zeros will show on the display.
2. Enter a one or two digit track number, then press Program.
3. Enter a one or two digit minute number, then press Program.
4. Enter a one or two digit second number, then press Program. The track will immediately begin play at the designated time.

EXAMPLE: Here is a program to begin play at Track 2, 1 minute and 11 seconds into the piece.

1. Press Access
2. Press 2 then Program
3. Press 1 then Program
4. Press 11 then Program

NOTE: When entering an access number, remember not to exceed the track's playing time while programming. When this occurs your access number will not be acknowledged.

PROGRAM/PROG on Remote: Standard track programming gives you the ability to select which tracks you would like to hear and the order in which you would like to hear them. This method of programming is short term and will be cleared when you press the Stop button. Once a program is written, basic functions like Pause, Repeat, Track forward, and Track Back work within the program. The program will be cleared from memory once the last programmed track is played or the Stop button is depressed. The program will continually play if the Repeat button is depressed. To temporarily stop play within a program, press the Pause button. Remember, Stop will erase the program.

SPECIAL NOTE: If you get confused with the sequence while in the middle of programming, press the Stop button and start again. This will clear all programming in temporary memory.

HOW TO WRITE A PROGRAM

1. Press the Program button on the front panel or remote control. The Program LED will be illuminated next to the display. This puts the machine in Program mode.

-
-
2. Select the track you want first in the program. You can use the Track Advance and Reverse buttons to select the track numbers or punch the number directly into the keypad.
 3. After you select the track, press the Program button again. The track you selected is now in program memory.
 4. Repeat this sequence for each track you want in your program.

EXAMPLE: Here is a sample program sequence

1. Press Program
2. Press 2, then Program
3. Press 4, then Program
4. Press 6, then Program
5. Press 8, then Program

Press Play and the program sequence 2, 4, 6, 8, will begin.

NOTE: While playing the program, the Track Forward, Track Back, Repeat, and Pause functions work within the program.

To clear the program memory press the STOP button.

DMS

The Disc Management System (DMS) allows a track program you have written to be saved indefinitely in the KPS-20's memory.

CAUTION: Please proceed slowly and follow the sequence carefully while learning to program DMS. The DMS function will appear to be malfunctioning if the sequence is changed.

How to Write a DMS Program

1. Press the Program button on the front panel or remote control. The program LED will be illuminated next to the display. This puts the machine in the program mode.
2. Follow the standard program instructions as described above.
3. Once the Program is written, press the DMS button on the front panel or remote control. Press the Program button and the DMS LED on the front panel will illuminate. The DMS program is now complete.

COMPLETE TRANSPORT FEATURES AND FUNCTIONS

EXAMPLE: Here is a sample DMS program sequence

1. Press Program
2. Press 1 then press Program
3. Press 3 then press Program
4. Press 5 then press Program
5. Press 7 then press Program
6. Press DMS
7. Press Program

The DMS program is now entered into the KPS-20's permanent memory. To play the program, press DMS, then Play. The DMS program sequence 1, 3, 5, 7, will begin.

How to PLAY a DMS Program

1. Insert the disc into the KPS-20.
2. Close the top cover. The DMS LED will illuminate indicating there is a DMS programmed disc in the machine.
3. Press the DMS button on the front panel or remote control.
4. Press Play. The Program LED on the front panel will illuminate and the DMS program will begin.

NOTE: If the Program LED is not illuminated, the KPS-20 has not recognized the DMS program and will play the disc in the normal way.

How to Erase a DMS Program

Once the disc is enclosed in the KPS-20 and the DMS program LED is illuminated, press the DMS button and immediately press the Stop Button. The DMS LED will extinguish, indicating the DMS program is erased.

This is a description of the additional features and functions common to the KPS-20i and KPS-20i/l. Please contact your KRELL dealer or the KRELL staff for assistance if there are any questions not covered in this Reference. Please refer to the KPS-20i and KPS-20i/l Typical System Setups illustrations on pages 24 and 25.

CAUTION: When making connections to this component or any other, make sure the power amplifier is OFF and the preamplifier is in the MUTE or STANDBY mode.

ANALOG OUTPUT CONNECTIONS

The KPS-20i and KPS-20i/l are equipped with two analog output configurations: Single-ended via RCA connectors and balanced via XLR connectors. If your preamplifier has high level balanced inputs, we recommend the balanced outputs be used. There are considerable sonic benefits to be gained with use of the balanced format.

The XLR pin configuration is described below.

- Pin 1 Ground
- Pin 2 Non-inverting (0°)
- Pin 3 Inverting (180°)

The left and right channel RCA and balanced outputs are labeled on the back panel. Care should be taken that the correct left/right orientation is maintained.

NOTE: These two outputs can be used to simultaneously feed different systems.

EMPHASIS LED

Emphasis is part of an encode/decode recording technique. Discs and/or tracks that were recorded with this process will cause the Emphasis LED to illuminate. When the Emphasis LED is lit the appropriate circuitry is activated to provide flat frequency response.

KPS-20i AND KPS-20i/l DETAILS

DIGITAL SOURCE TO KPS-20i INTERLINK CONSIDERATIONS

Care should be taken in selecting the type of cable used to link a digital component to the KPS-20i or KPS-20i/l. Although the KPS-20 series will accept all industry standard formats, we suggest using the ST wide bandwidth format. Refer to the KPS-20i Typical System Setup on page 24.

DIGITAL INPUT CONNECTIONS

The KPS-20i and KPS-20i/l come standard with most current digital input formats: ST fiber optic, AES/EBU balanced, EIAJ fiber optic, and two SPDIF coaxial inputs.

Connect the sources' digital output(s) to one of the digital inputs on the KPS-20i or KPS-20i/l. When the corresponding input of the desired digital source (must be ON) is selected, the appropriate input indicator LED will illuminate. The Sync LED will then illuminate, indicating the digital source and internal processor have linked. The Processor automatically selects the correct input frequency for the source.

DIGITAL OUTPUTS

The KPS-20i comes standard with one coaxial digital output. Signal from the input selected on the front panel or remote is routed to this output for sending to a digital recording device or external D/A processor.

An optional Digital Output Module is available to provide additional outputs in ST optical and EIAJ optical formats. Also included is a second ST output that can be internally switched between the normal digital output and Krell's proprietary Time Sync system. Please refer to pages 16 through 18 for more information about the connection of digital outputs and Time Sync.

All input and output connections for the KPS-20i/l are identical to those for the KPS-20i, with the exception that the KPS-20i/l analog outputs connect directly to the inputs of a power amplifier or crossover. Please review the KPS-20i/l Typical System Connection Diagram on page 25.

Operation of the KPS-20i/l is identical to the KPS-20i with the exception of the volume control. The operation on the volume control and associated display are detailed below.

VOLUME CONTROL

The KPS-20i/l utilizes a discrete ladder network volume control. When volume Up or Down is selected via the front panel or the remote control, the numeric display will provide a 0—158 step indication of the volume level. The level position will remain on the display for a few seconds and then return to the transport display mode.

To adjust listening level hold down either the volume Up or Down button. The volume will begin increasing or decreasing in one step increments. After a short time, the volume will begin changing in larger, multi-step increments. This is intentional and allows for more rapid changes in volume adjustment.

To check your volume level without changing the level, briefly depress either the volume Up or Down button. The display will show your present volume level for a short time before returning to the transport display mode.

CAUTION: Do not connect the output of the KPS-20i/l to the input of a preamplifier. The KPS-20i/l output is designed for connection directly to the input of an amplifier and may damage a preamplifier input.

KPS-20t DETAILS

All operational features and functions of the KPS-20t are described on pages 7 through 12 of the Reference. Detailed below are various issues related to the connection of the digital outputs. This information is also valid for the KPS-20i and KPS-20i/l if the optional Digital Output Module is installed. Please refer to the KPS-20t Typical System Setup on page 26 for a detailed view of how the KPS-20t is installed in an audio system.

CAUTION: When making connections to this component or any other, make sure the power amplifier is OFF and the preamplifier is in the MUTE or STANDBY mode.

DIGITAL OUTPUT CONNECTIONS

The KPS-20t comes standard with all current digital output formats: ST fiber optic, AES/EBU balanced, SPDIF coaxial, EIAJ optical and KRELL Time Sync.

Connect the digital output(s) of the KPS-20t to the input(s) of a digital recording device and/or digital-to-analog processor.

The KPS-20t is also fitted with Time Sync. Time Sync is a proprietary system that locks the clocks of the transport and certain KRELL processors. For a complete description of Time Sync, see page 18.

If you are using the Time Sync option, connect an ST cable between the KPS-20t Time Sync output and Time Sync input on a Krell processor.

For specific instructions on connecting ST cables refer to page 17.

TRANSPORT TO PROCESSOR INTERLINK CONSIDERATIONS

Care should be taken in selecting the type of cable used to link your KPS-20t and processor. We suggest using the ST wide bandwidth fiber optic format. This format has a data rate of approximately 50 megabit. This allows accurate transmission of the digital bit stream without data corruption and proves to be sonically superior. Using a fiber optic interconnect also reduces ground loop problems often associated with quality audio systems.

If coaxial cable is used, it should be non-capacitive and have a bandwidth in excess of 10 MHz to prevent drop-out errors. For best results with coaxial cable we recommend the AES/EBU balanced format. The AES/EBU format is a ± 5 volt balanced digital transmission. Because of the high voltage balanced format, this system allows for accurate data transmission and has great sonic advantages over standard single-ended coaxial or EIAJ fiber optic formats. The AES/EBU coaxial cable must have two conductors and a shield for balanced termination.

HOW TO CONNECT ST CABLES

1. Remove the plastic cover from the outside of the ST transmitter (located on transport) and receiver (located on processor).
2. Remove the plastic cap from both ends of the ST cable.
3. Locate the key tab on the end of the ST cable.
4. Locate the slot on the top of the ST receptacle.
5. Slide the cable connector into the ST receptacle, with the key guided into the designated slot.
6. Gently push the connector into place, depress the internal spring, and twist the outer collar clockwise to secure the outer ring to the posts on the chassis connector.
7. Use the same procedure for the processor input.

ST/TIME SYNC OUTPUT

The ST connector labeled ST/Time Sync can be switched between Time Sync and a normal data output. The KPS-20t comes with this output set for Time Sync. Follow the procedure below to switch it to a data output:

1. Turn the power amplifier Off and the preamplifier to Mute or Standby
2. Turn the two thumbscrews counterclockwise until they release from the chassis
3. Hold the thumbscrews and pull the panel/board assembly straight out of the unit
4. On the circuit board there is a switch labeled Time Sync on one side, Data on the other
5. Move the switch to the Data
6. Slide the board back into the chassis
7. Firmly press the board into its mating connector
8. Turn the thumbscrews clockwise until they are tight

TIME SYNC

TIME SYNC

Time Sync is an independent clock data transfer system that was developed to eliminate recovery jitter. Time Sync couples the high speed master clock output from the transport directly to the processor. This means there is one system master clock for the transport and processor. The use of the Time Sync system requires that a KRELL processor be equipped with a Time Sync input. It also requires that the Time Sync output of the KPS-20t be connected to the Time Sync input of the processor using an ST fiber optic cable.

With Time Sync operating, the processor does not use a recovered clock generated by its decoder. Instead, the transport's clock feeds the input of the DACs. This process eliminates 100% of the jitter corruption inherent in all clock recovery type systems. The ST interface was chosen for its high data rate and its immunity to radiated R.F. and 60 cycle noise corruption.

Refer to the KRELL D/A Processor's Owner's Reference for Time Sync operating instructions.

REMOTE CONTROL OPERATION

The KPS-20 comes equipped with a universal remote control from which basic preamp, amplifier, processor, and complete transport functions can be controlled. A brief description of the buttons and their functions is provided. A diagram of the remote control is provided on page 21. All KPS-20 functions can be controlled from the front panel or the remote control. Basic preamp and amplifier functions are listed below.

REMOTE ONLY FUNCTIONS

(AMP) POWER: Turns KRELL Audio Standard or S-Series amplifiers On or Off.

(AMP) METER: Turns KRELL S-Series amplifiers bias level meters On or Off and cycles through KRELL Audio Standard meter functions.

There are three buttons on the face of the remote control marked PLAYER, PREAMP, and D/A. These buttons determine which type of KRELL component the remote control will address. When one of these function buttons is selected, the LED directly above that button will flash. These buttons affect only the functions beneath them.

PLAYER: When engaged, the remote control addresses a KRELL CD Player. Control of digital input selection is available for the KPS-20i and KPS-20i/l. Control of volume and mute are available for the KPS-20i/l.

PREAMP: When engaged, the remote control addresses a KRELL remote control preamplifier. Control of Volume, Phase, Input Select, and Mute are accessible from the remote control.

D/A: When engaged, the remote control will address future KRELL processors. This button is not used for the KPS-20 Series.

REMOTE CONTROL

BATTERY INSTALLATION AND REMOVAL

NOTE: Batteries should be replaced when functions from the remote control become intermittent. The KPS-20 universal remote uses two AAA size 1.5 volt batteries.

1. With the T-10 torx driver remove the four screws from the remote control back plate.
2. Remove the back plate to expose the batteries.
3. Remove the old batteries and install new ones, following the battery position diagram on the plastic battery receptacle.
4. Re-install the back plate and four screws.
5. Check to make sure the remote control is functioning properly.
6. Tighten the four back plate screws.

If you have questions about the remote control operation contact the KRELL staff for assistance.

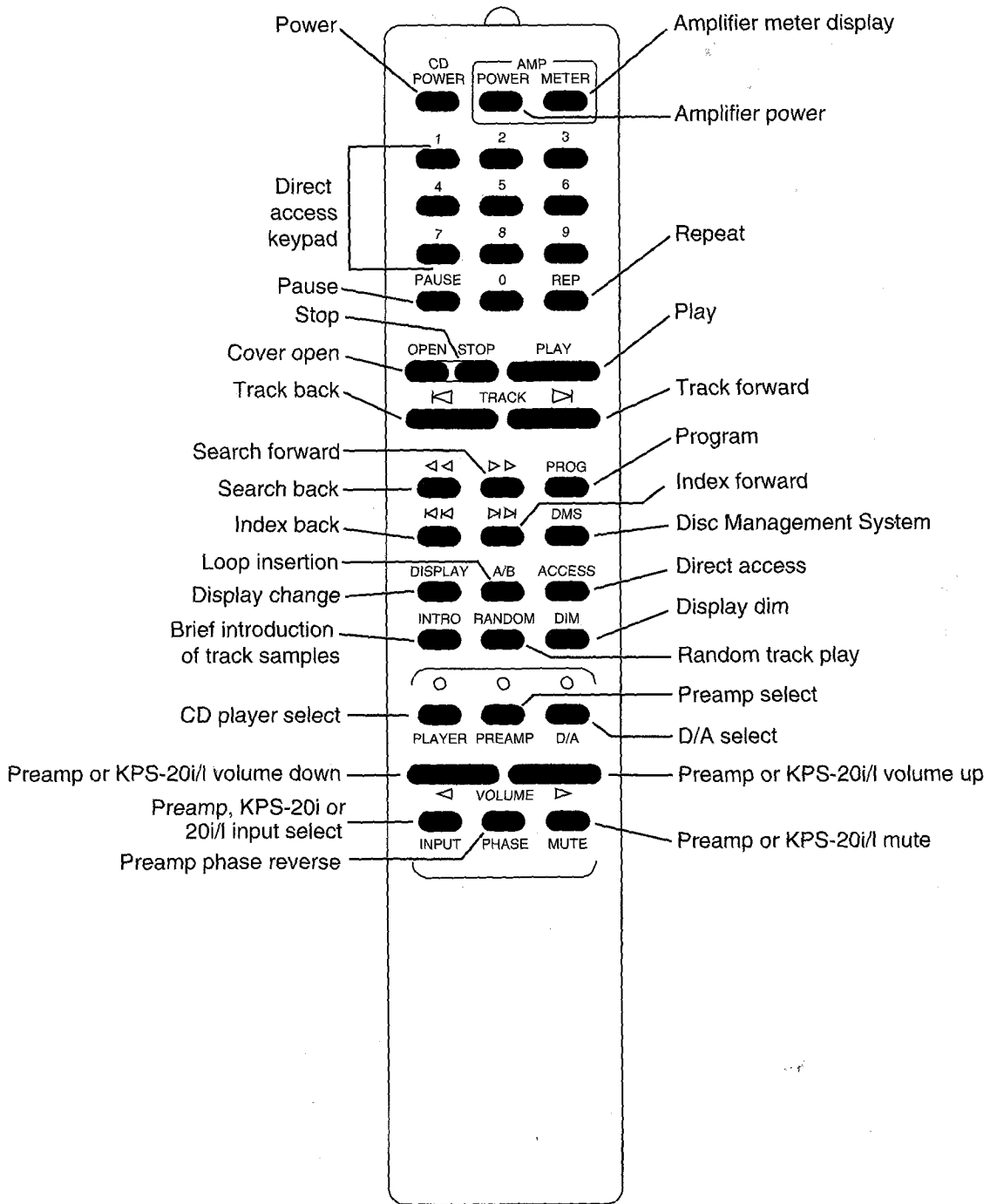

QUESTIONS AND ANSWERS

Q. My CD transport has both fiber optic and coaxial outputs. Which one should I use?

A. Given a choice, we prefer the ST format due to its complete isolation of the grounds between digital source and processor. This minimizes the possibility of ground loops in the digital components. The ST format also has the added benefit of substantially higher bandwidth than coaxial or the standard fiber optic interface. If a coaxial cable must be used, we suggest the AES/EBU balanced format. This format utilizes a $\pm 5v$ digital format and has the additional benefit of balanced termination.

Q. Will I damage my KPS-20 if I leave the power ON all the time?

A. No it's intended to be on at all times. The circuits perform more consistently once they reach thermal equilibrium.

NOTE: For the protection of your unit, we recommend disconnecting the AC cord from the wall outlet before any electrical storms or if you plan on being away from home for prolonged periods of time.

Q. I have some very fine audiophile interconnect cable which has superior sonic characteristics. Can I use this for my coaxial digital input?

A. You may experiment with any high quality cable. Note that most audio interconnect cable is not designed to carry the ultra-high frequency information of the digital bit stream.

NOTE: For the KPS-20, we recommend non-capacitive coaxial cable which has a bandwidth in excess of 10MHz and excellent shielding properties. This is true on both RCA and XLR terminated cables.

Q. When I try to play a certain disc the KPS-20 displays an error message and will not play. Is the transport defective?

A. Check to make sure the magnetic clamp is properly centered on the disc. If this is not the problem, the disc may need to be cleaned. If the surface of the disc is soiled the laser cannot read the data and will display an error message or skip sections of tracks. You may want to experiment with some of the compact disc cleaning products. If after cleaning the disc, it still will not play, the problem may be with the indexing on the CD. Some recording companies stretch the parameters of the CD, preventing them from

KPS-20i TYPICAL SYSTEM SETUP

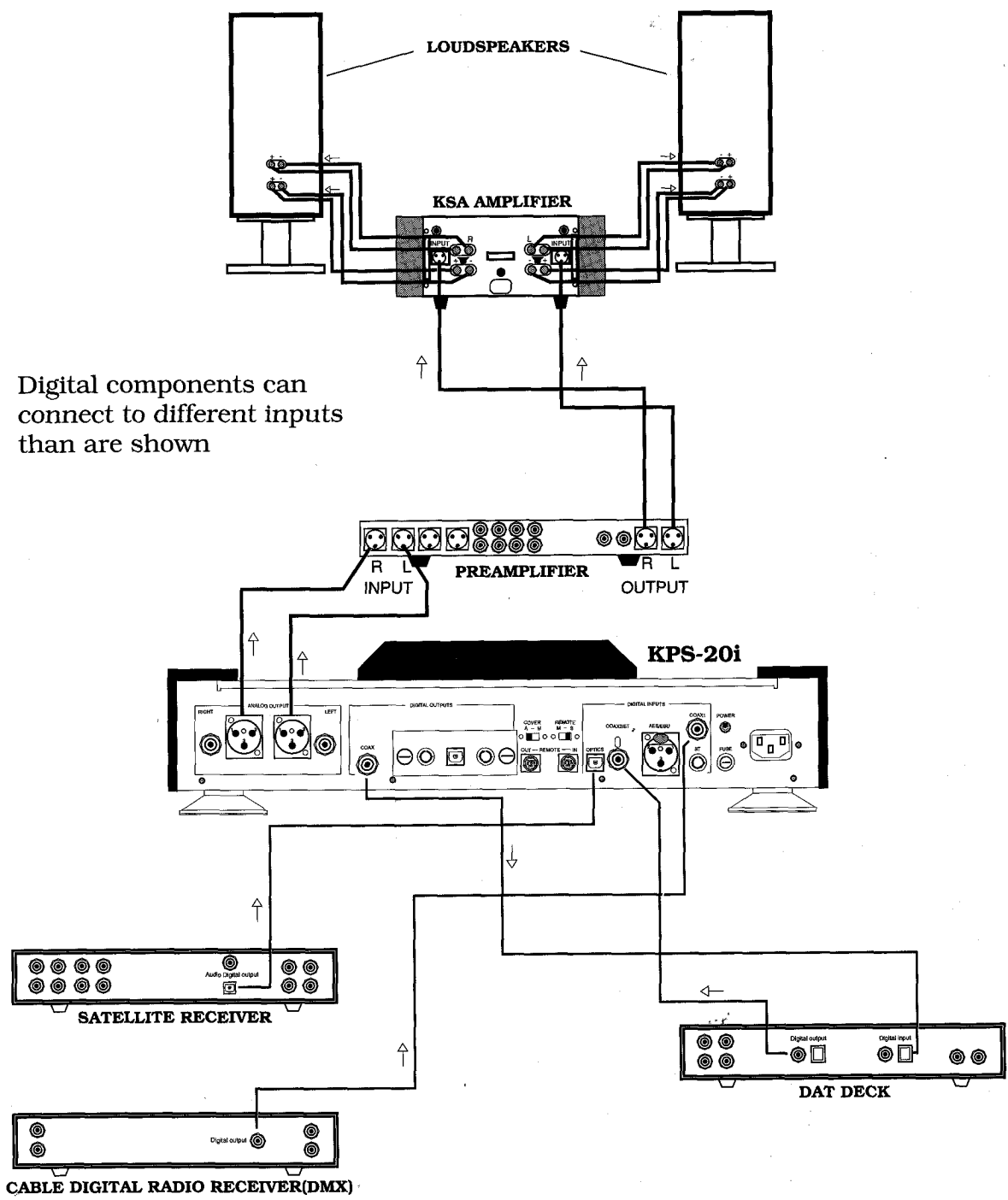

KPS-20i/1 TYPICAL SYSTEM SETUP

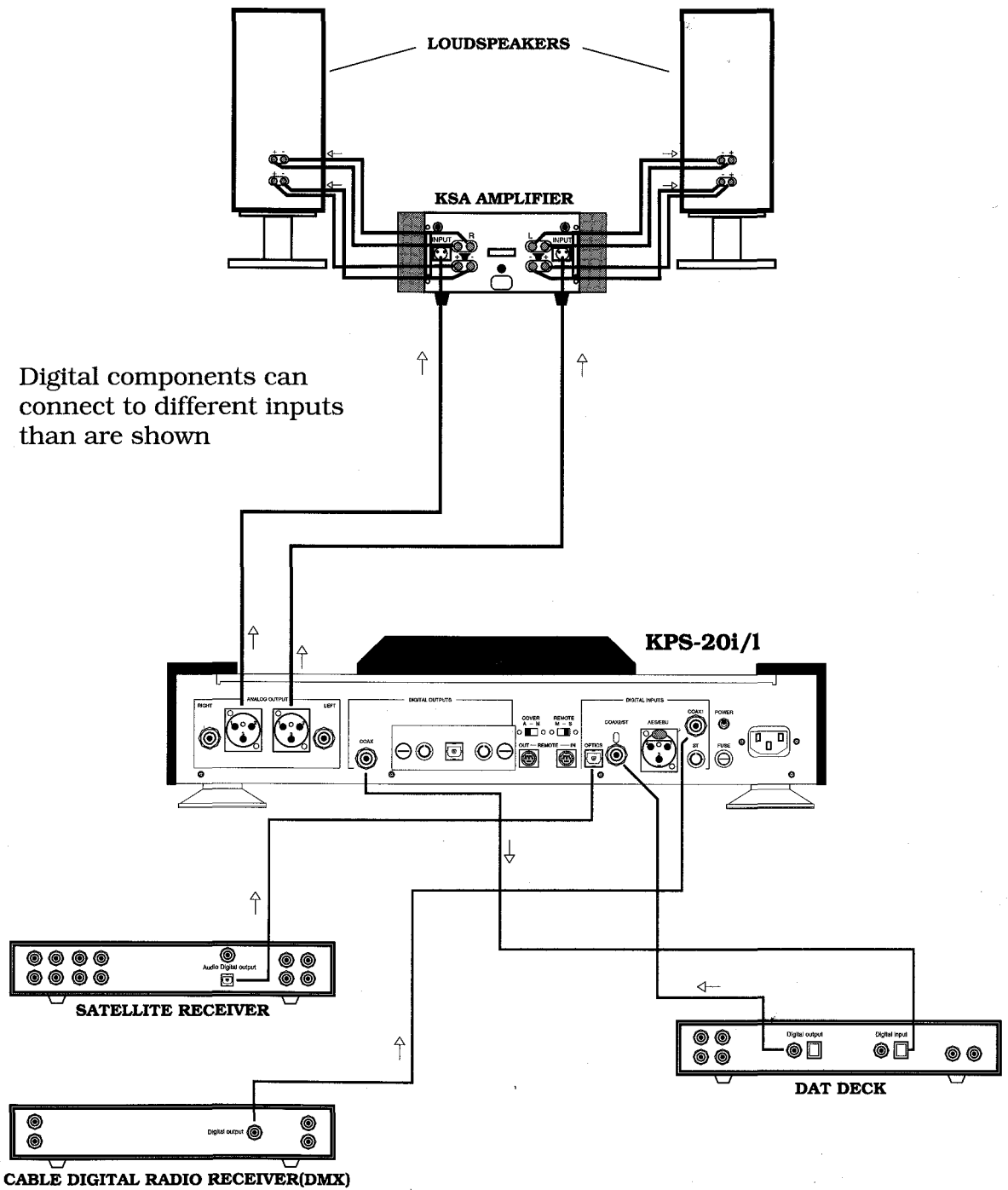

KPS-20t TYPICAL SYSTEM SETUP

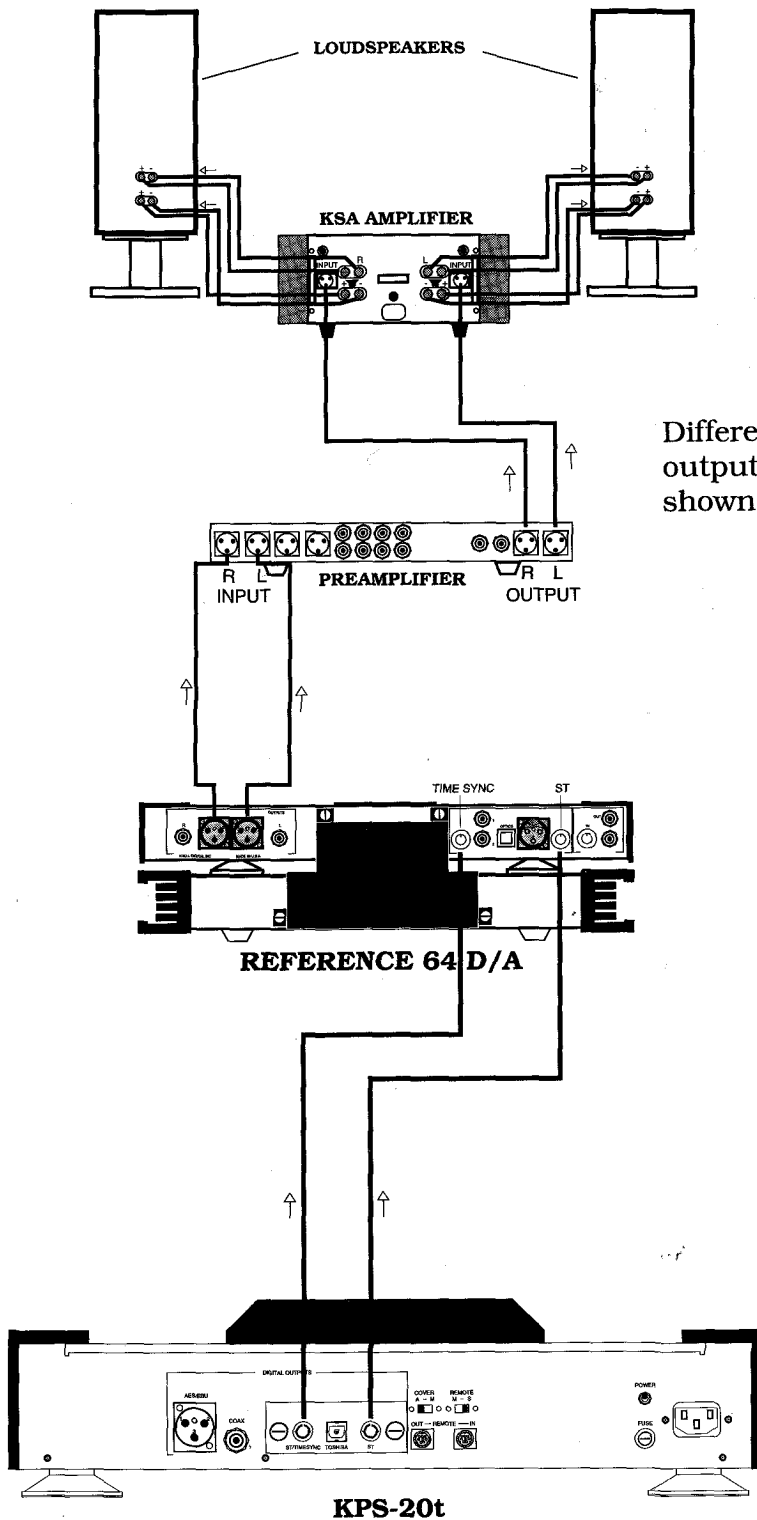

Different digital outputs than are shown can be used

TRANSPORT:

Modified CDM-9 pro with hall effect motor, swing-arm design in a unicast frame. Custom magnetic disc clamp.

LASER:

Single beam with a glass lens

TOP COVER:

Gear driven mechanism; auto or manual control

CONTROL FUNCTIONS:

KRELL written keypad processing software

KPS-20i and KPS-20i/l ANALOG OUTPUTS:

Balanced via XLR connectors
Single-ended via RCA connectors

KPS-20t DIGITAL OUTPUTS:

ST Optical, EIAJ Optical, AES/EBU balanced, S/PDIF coax
2nd ST Optical switchable between data and Krell Time Sync

KPS-20i and KPS-20i/l DIGITAL OUTPUTS:

S/PDIF coax

KPS-20i and KPS-20i/l DIGITAL OUTPUT MODULE OPTION:

ST Optical, EIAJ optical, 2nd ST Optical switchable between data and Krell Time Sync

KPS-20i and KPS-20i/l DIGITAL INPUTS:

ST Optical, EIAJ Optical, AES/EBU balanced, two S/PDIF coax
Note: 2nd coax input can be fitted with ST format optical on request

REMOTE CONTROL:

Multi-function wireless infrared with additional control of Krell amplifiers and preamplifiers

WEIGHT:

Unit weight: 36 lbs.
Boxed weight: 50 lbs.

DIMENSIONS:

19" W x 14.5" D x 4.75" H

All operational features, functions, and specifications and policies are subject to change without notification.

WARRANTY AND SERVICE

THERE ARE NO USER-SERVICEABLE PARTS INSIDE ANY KRELL PRODUCT.

KRELL PLAYBACK SYSTEM-20 has a limited and transferable warranty of five years for parts and labor and three years on transport related parts. The warranty period begins on the date of retail purchase, as noted on the retail sales slip provided by an authorized KRELL Dealer or Distributor, or on the warranty registration card sent to KRELL. In the event adequate proof of purchase date is unavailable, the warranty period will begin on the date the unit was originally shipped from the factory. The original ship date can be determined by KRELL from the serial number.

The warranty for KRELL products is valid only in the country to which they were originally shipped, through the authorized KRELL Distributor for that country, and at the factory. There may be restrictions on, or changes to KRELL's warranty because of regulations within a specific country. Please check with your Distributor for a complete understanding of the warranty in your country.

Freight to the factory is your responsibility. Second day return freight within the United States is included in the warranty. If you have purchased your KRELL product outside the United States and wish to have it serviced at the factory, all freight and associated charges to the factory are your responsibility. Krell will pay return freight to the US-based freight forwarder of your choice. Freight and other charges to ship the unit from the freight forwarder to you are also your responsibility.

The operating voltage of this unit is determined by the factory and can only be changed by an authorized KRELL Distributor or at the factory. The voltage for the KRELL PLAYBACK SYSTEM-20i in the USA can not be changed until six months from the original purchase date. Any unauthorized voltage conversion, disassembly, component replacement, perforation of chassis, updates, or modifications performed to the unit will void the warranty.

KRELL is not responsible for any damage incurred in transit. KRELL will file claims for damages as necessary for units damaged in transit to the factory. You are responsible to file claims for shipping damages during the return shipment.

The use of any packing material other than original is not recommended. KRELL may, at its discretion, pack a unit in new packing for the return shipment and bill you for such packing if the unit was packed in non-standard packing or the original packing is so damaged as to be unusable. Should you need to purchase additional packaging please contact your authorized KRELL Dealer, Distributor or KRELL for assistance.

IMPORTANT: If you think there are problems with your unit, please contact your Dealer, Distributor, or the factory immediately. Do not return any unit to KRELL for repair without first calling to discuss the problem and to obtain a Return Authorization number.

All operational features, functions, and specifications and policies are subject to change without notification.

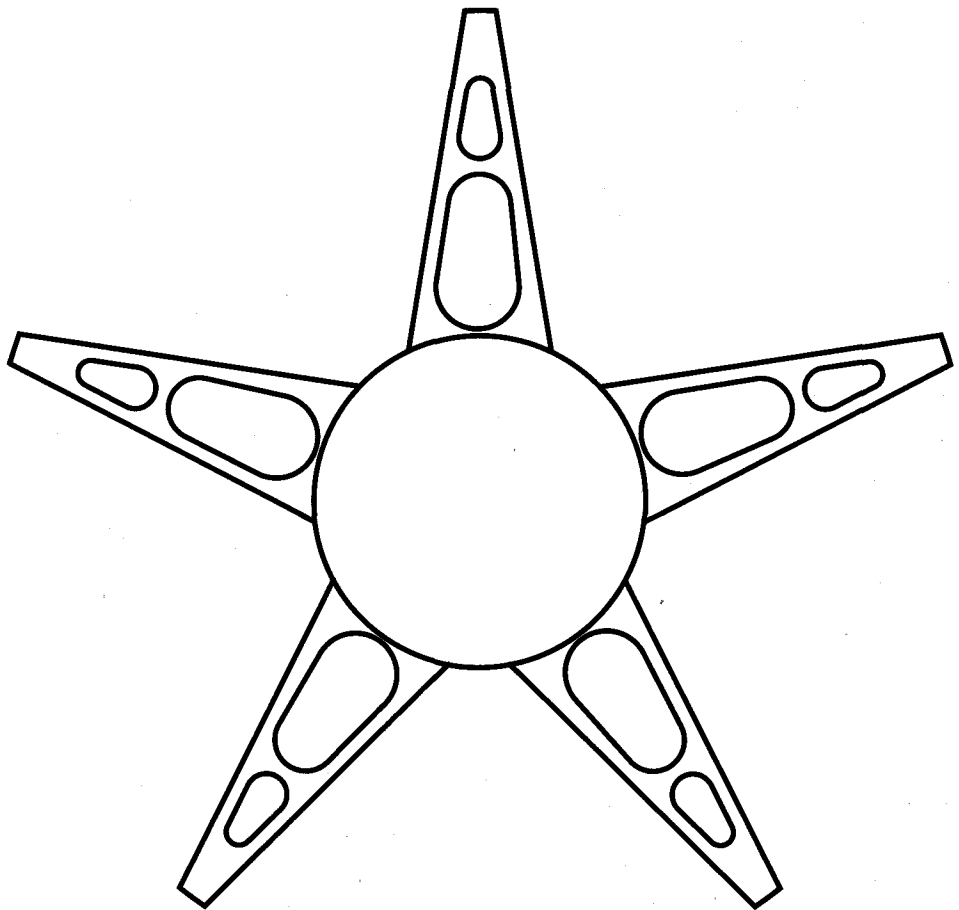

KRELL

45 Connair Road ■ Orange, CT 06477

203-799-9954 ■ Fax: 203-799-9796

Copyright 1995 KRELL

P/N D960601600000